



0191-8141(94)E0033-U

Northwest-verging folds and the northwestward movement of the Caledonian Jotun Nappe, Norway

HAAKON FOSSEN

Statoil, GF/PETEK-GEO, N-5020 Bergen, Norway

and

TIMOTHY B. HOLST

Department of Geology, University of Minnesota Duluth, Duluth, MN, 55812, U.S.A.

(Received 12 February 1993; accepted in revised form 24 February 1994)

Abstract—A family of asymmetric, northwest-verging back folds and crenulations occur on a regional scale in the Caledonian décollement zone in southwestern Norway. They are the result of reversal of the emplacement movement of the Jotun and other nappes in Early Devonian time. The back folds may have formed progressively by two different mechanisms: actively by buckling of the layering, and more passively by transfer of slip across the layering (reverse-slip crenulations) to balance the thinning of the zone caused by foliation-parallel slip and shear band formation. The former mechanism is considered to be most important during the initial stages of fold development, gradually giving way to the latter mechanism. The hinge lines of these folds appear to have remained stationary during deformation. This is explained by the observation that the hinge lines lie within or close to the shear plane, i.e. the plane of no rotation in simple shear deformation.

Integration of strain across the deformation zone indicates a magnitude of back movement in the order of *ca.* 20–36 km, and it is argued that the deformation was close to simple shear.

INTRODUCTION

A family of NW-verging asymmetric folds occur in the sheared rocks in the basal décollement or thrust zone in the Scandinavian Caledonides in southern Norway. They have been identified and mapped under the Jotun Nappe in the Sognefjell area (Roberts 1977, Banham *et al.* 1979, Twist 1985, Lutro 1990), in the Bergsdalen Nappes (Gray 1978, Fossen 1992a, 1993a), and in the Haukelid area (Naterstad *et al.* 1973, Andresen 1974). Although some have realized that these folds imply northwestward movement of overlying Caledonian nappes that are generally known to have experienced substantial SE-directed Caledonian thrust movements, their large-scale kinematic implications have been unclear and a matter of discussion (Banham *et al.* 1979, Twist 1985, Milnes & Koestler 1985, Andersen 1993). Recent work indicates that they formed during northwestward movement of the Caledonian nappes after a prolonged period of Caledonian thrusting (Fig. 1), and that they are an early expression of a period of significant extensional tectonics which indicate a rapid switch from convergent to divergent plate motions in the early Devonian Caledonide setting (Fossen 1992b, Fossen & Rykkelid 1992). The purpose of this paper is to further discuss the origin of these folds and to try to extract information about the nature and amount of northwestward movement of the Caledonian nappes.

THE STUDY AREA

The Caledonides of southwest Norway (Fig. 2) (Bryhni & Sturt 1985) were built upon the Precambrian Baltoscandian Shield (basement), of which only the western part (Western Gneiss Region) was significantly involved in Caledonian deformation. An Upper Proterozoic to lower Paleozoic sedimentary cover (phyllite and quartzite) to this basement acted as the principle décollement during Caledonian collision, above which the large Jotun and Ryfylke nappe complexes and other units of the Middle Allochthon (Bryhni & Sturt 1985) were emplaced (see Hossack & Cooper 1986 for a discussion of the thrusting history). The Bergsdalen Nappes (Kvale 1948) are interpreted as slices of Precambrian basement (Proterozoic quartzite, quartzite-schist, mica-schist, metadacite, metarhyolite, granite, monzonite, gabbro etc) that were tectonically incorporated with the mostly phyllitic Upper Proterozoic to lower Paleozoic metasediments (Fossen 1993a). The décollement zone, as defined in this paper, consists of phyllites and internally sheared allochthonous lenses of sedimentary and crystalline, Precambrian rocks.

The Ordovician–Silurian thrusting caused intense deformation and mylonitization, particularly within and near the décollement zone, and resulted in SE-directed nappe displacements of several hundred kilometers (e.g. Gee 1978, Hossack & Cooper 1986). Although the

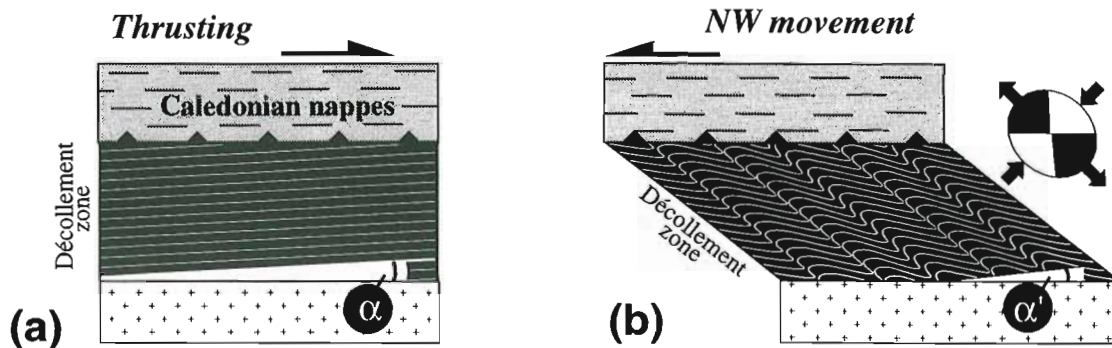

Fig. 1. A shear zone with an internal layering initially inclined to the boundaries as shown in (a) is likely to result in the development of asymmetric folds with a vergence corresponding to the sense of shear (b). This schematic illustration can be thought of as a vertical NW-SE section through the décollement zone during (a) thrusting (D_1) and (b) back movement (D_2). The planar fabric and lithological layering in the décollement zone made an acute angle (α) with the shear zone at the end of the thrusting. This geometry explains the widespread formation of folds or reverse-slip crenulations during D_2 (b). The orientation of the incremental strain ellipse is indicated in (b).

strains and displacements involved in the thrusting history are formidable, the general, thin-skinned deformation pattern in the study area is relatively simple. Thus, for our purpose, we will refer to the thrusting event as D_1 , although the associated deformation structures may locally indicate a polyphasal deformation

history that cannot easily be correlated on a regional scale (e.g. Milnes & Koestler 1985).

The thrusting deformation was followed by a Devonian (Fossen 1993b) phase (here referred to as the D_2 event, see Table 1) of top-to-the-(north)west back movement of the Caledonian nappes and stretching of

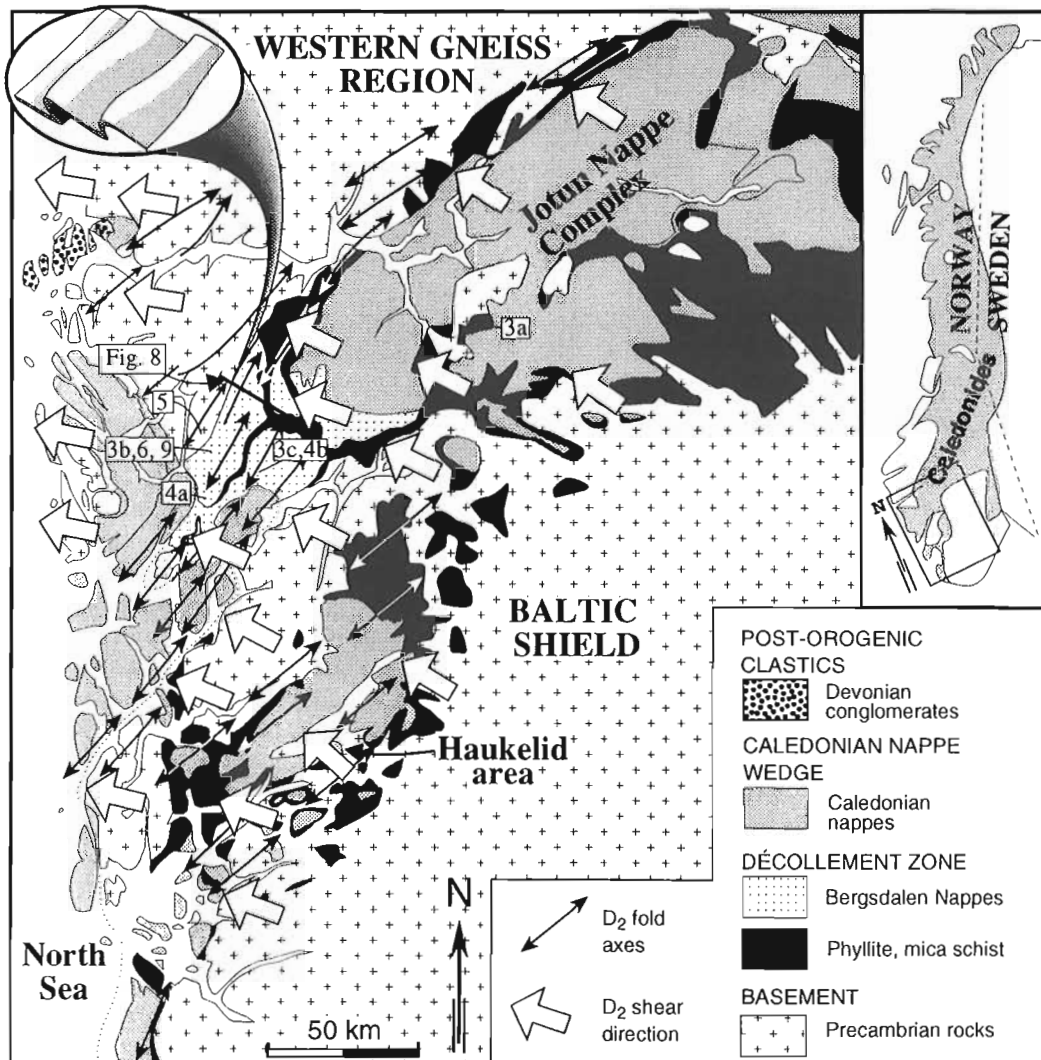

Fig. 2. Geological map of southwestern Norway, showing trend of hinge lines and sense of shear during the extensional, post-Caledonian D_2 phase. The vergence of the folds is to the northwest (as indicated in the superimposed sketch).

Northwest-verging folds in the Jotun Nappe

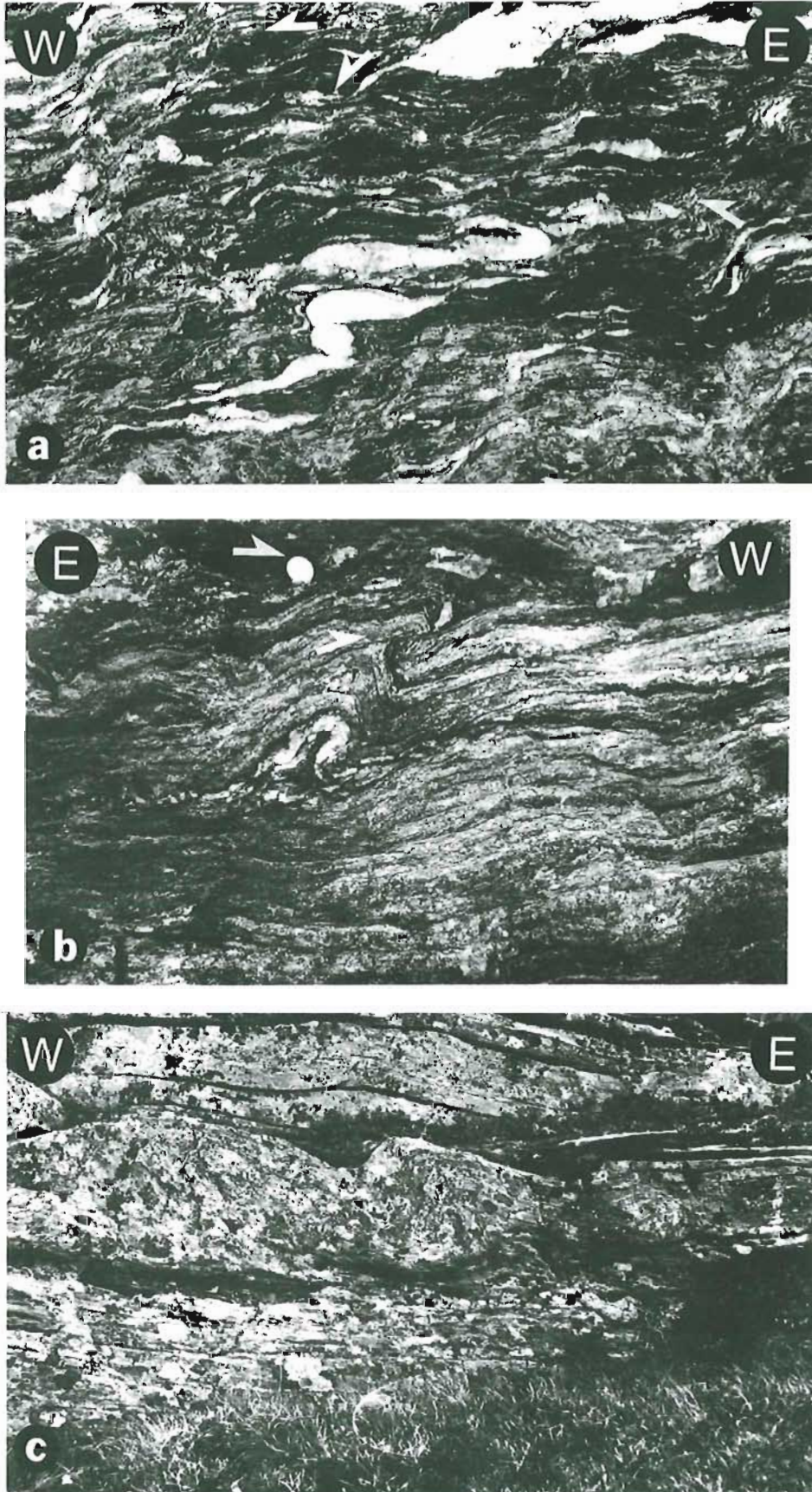

Fig. 3. Structures formed in the décollement zone during the back movement of the Jotun Nappe. (a) Closely associated shear bands and folds in the phyllite, Aurlandsdalen. White arrows indicate general sense of shear (top arrow), shear along shear bands, and reverse slip (lower right arrow). Width of photograph is about 18 cm. (b) Single fold in layered tectonites, Evanger, Lower Bergsdalen Nappe. Note discrete slip surface in upper part. White arrows indicate sense of shear. Coin is 1 cm in diameter. (c) Asymmetric folds in a *ca.* 30 cm thick quartzite layer between two weaker, micaceous layers, Godalseggene, Upper Bergsdalen Nappe.

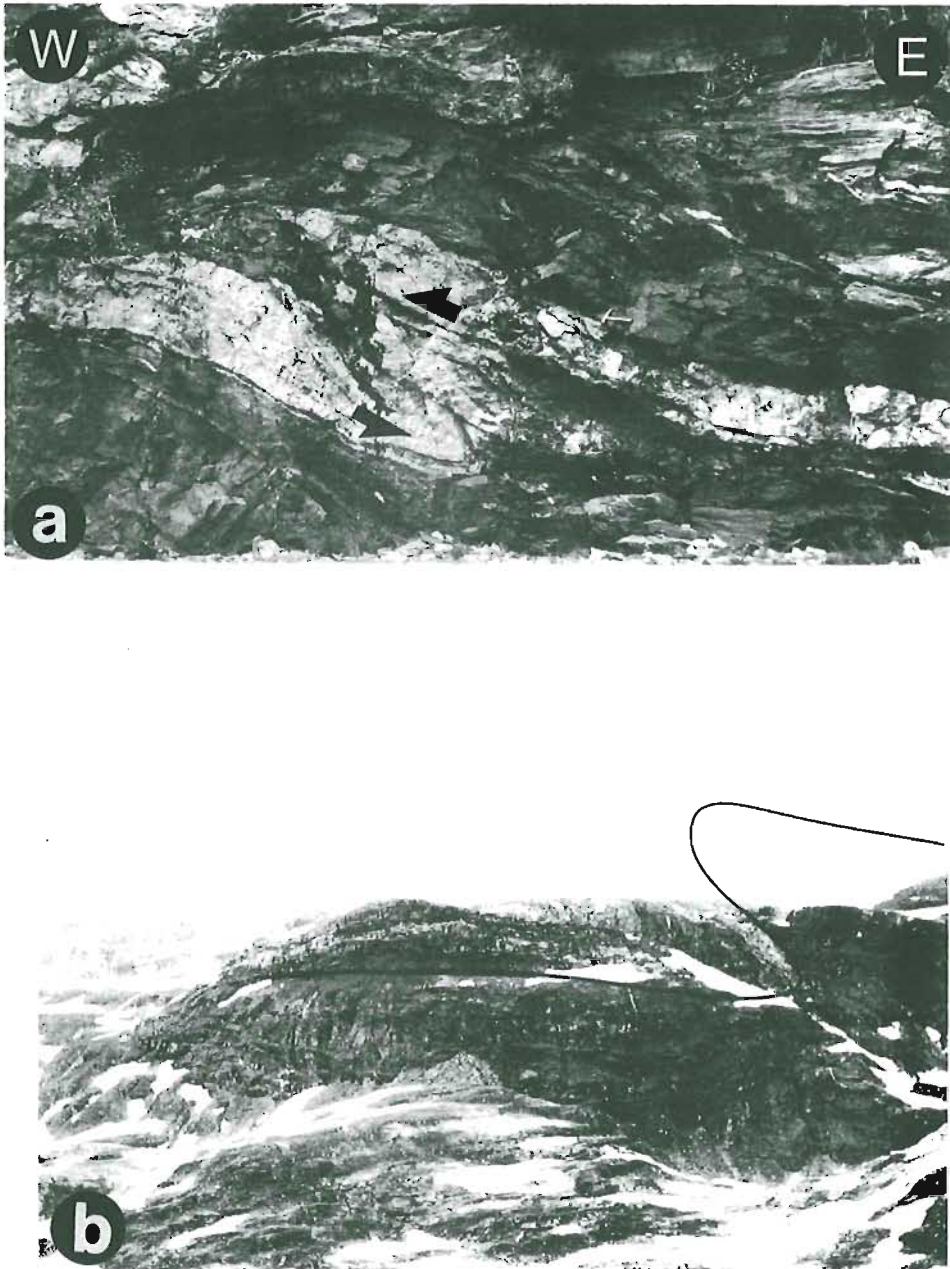

Fig. 7. (a) Thrust-like structure indicating shortening of the light granitic dike in the dark biotite gneiss, Lower Bergsdalen Nappe (Eikedalen). (Note fold hinge preserved to the right of the lower arrow.) The width of the photograph is about 10 m. (b) Large-scale fold in the Upper Bergsdalen Nappe, looking NNE. The cliff is about 200 m high.

the basement (Fossen & Rykkelid 1992). The D_2 phase is recognized by clear-cut W- to NW-verging structures that overprint SE-verging structures related to thrusting. Evidence for this two-phase kinematic history is present on a regional (Fossen 1992b) as well as on a local (Fossen 1993a) scale in the décollement zone in southwest Norway, and the focus of this article is on the widespread back folding that occurred during D_2 (Fig. 1b).

THE FOLD STRUCTURES

A variety of linear and planar fabrics developed in the décollement zone during the Caledonian thrusting. The most significant expression of this deformation is a pervasive L - S fabric that varies from weak to moderate in the least deformed plutonic rocks in the Bergsdalen Nappes, to an intense mylonitic fabric in most other lithologies. This fabric was affected by the subsequent D_2 deformation during northwestward movement of the overlying Jotun Nappe and related units. The fairly stiff and laterally extensive overlying nappes must have moved quite uniformly northwestward above the décollement zone, and it was not until the end of or after the northwest movement history that they were cut by down-to-the-NW faults, e.g. the Lærdal-Gjende fault (Milnes & Koestler 1985, Fossen 1992b). It is therefore assumed that the back folds and related D_2 structures formed more or less contemporaneously throughout the décollement zone. The metamorphic conditions during the formation of the back folds varies from middle greenschist facies (biotite and white mica stable) in the Bergsdalen Nappes area (Fossen 1993a) to lower greenschist facies southeast of the Jotun Nappe and the Haukelid area (Fig. 1).

The asymmetric, NW-verging D_2 folds and crenulations are common on a millimeter to centimeter scale in laminated, mica bearing rocks. Zones of crenulations typically alternate with about equally thick zones of shear bands (Fig. 3a). The crenulations and folds are common where layers of apparently higher competence occur, typically quartz-rich bands or veins. These structures are different from classical crenulation cleavage

related to higher-order folds in that they are restricted to small domains within the tectonites, and cannot be traced continuously for very far before they die out or merge into shear bands or small shear zones.

Outcrop-scale folds may be separate, first-order structures, or may be parasitic to larger-scale folds. The first type are intrafolial folds that occur as single, asymmetric folds (Fig. 3b), or more typically as trains of asymmetric folds, formed in competent layers between weaker, micaceous layers (Figs. 3c and 4). These folds are restricted to relatively narrow sequences within the tectonites, and rapidly die out across the layering (Figs. 3b & c and 5). All these folds are overtuned to the northwest, with axial surfaces dipping moderately to the southeast (Fig. 6). In some cases discrete slip has occurred in the hinge zone of intrafolial folds (Fig. 3b). Less commonly, layer-parallel slip surfaces have dismembered the fold completely, and completely dominate the structure (Fig. 7a). This has been observed only on centimeter to meter-scale folds, and does therefore not significantly affect the strain calculations carried out on larger folds below. The hinge lines exhibit some variations which locally can be ascribed to noncylindricity of individual folds, but the general trend of about 045 is relatively well defined (Figs. 2 and 6).

The largest folds are found in the Bergsdalen Nappes (Figs. 7b and 8). They have short limbs of several hundred meters length, and have been mapped as NW-verging structures with subhorizontal, NE-trending axes, very similar to the minor folds. The hinge lines appear to be even more constant for these large-scale structures than for the smaller-scale folds. Second-order outcrop-scale folds typically occur in the hinges of the large folds. The large folds formed where the lithological layering is defined by thick sheets of relatively competent lithological units, e.g. 50–1000 m thick layers of foliated granite or quartzite. The competent sheets are typically caught between zones of phyllite or other weak rocks that show strong, asymmetric D_2 fabrics (S - C fabrics etc.) indicative of high D_2 shear strains.

Altogether, both large and small-scale structures have very similar geometry and spatial orientation, and the folds/crenulations tend to be restricted to zones between weak layers of relatively higher D_2 shear strain.

Table 1. Terminology of previously described deformations/structures corresponding to the D_2 deformation/ F_2 folds discussed in this paper

Authors	Terminology	Area
Naterstad <i>et al.</i> 1973	'Relatively open folds trending 045°'	Haukelid area
Andersen 1974	F_4/S_4	Haukelid area
Roberts 1977		
Banham <i>et al.</i> 1979	D_3/F_3	NW side of Jotun Nappe
Twist 1985		
Milnes & Koestler 1985	Stage 3: D_2 in Fortun Fm. D_2 in Vang Fm. D_4 in Turtagrø zone	SE side of Jotun Nappe NW side of Jotun Nappe NW side of Jotun Nappe
Milnes <i>et al.</i> 1988	D_2/F_2	Sognefjord (WGR)
Lutro 1990	F_3	NW side of Jotun Nappe
Fossen 1992a,b, 1993a-c	D_2/F_2	Bergsdalen Nappes
This work	D_2/F_2	See Fig. 2



Fig. 4. Illustration of folds developed above a weak slip zone in gneissic tectonites in the basement below the Bergsdalen Nappes (near Straume). The reverse slip component caused by the folding is indicated. Based on field sketch and photograph.

FOLD ORIENTATION

The hinge lines are subhorizontal and have a well-defined northeast–southwest trend (Fig. 6), and highly noncylindrical folds are uncommon. It is well known that hinge lines formed at any orientation not lying within the shear plane will, for simple shear, progressively rotate towards the maximum finite strain axis (λ_1) and the shear direction with increasing strain (e.g. Skjerna 1980). In the study area, most hinge lines make a considerable angle with λ_1 and the shear direction (Fig. 9), which from fiber and stretching lineations found in zones of mylonitic D_2 deformation (Fossen 1993c), is inferred to have a northwest trend. One might therefore expect that folds that have experienced the greatest strain will have axes closest to λ_1 and the shear direction. To distinguish between folds that have experienced much and little shear deformation, we adopt the general assumption that folds tighten by increasing shear strain, an assumption that is in agreement with physical and numerical models for fold development in shear regimes (e.g. Hudleston 1977, Cobbold & Quinquis 1980, Vollmer 1988). However, Fig. 9 shows that there is no significant difference in orientation between tight and open folds. This indicates that rotation of hinge lines was not important during deformation, but the folds rather initiated with axes close to their present orientation.

A simple explanation for the stationary hinge lines may be found from the field data. Figures 10(a) & (b) shows that the hinge lines lie close to the décollement

zone or shear plane. Since the shear plane is the plane of no rotation in simple shearing, a dominance of simple shear during D_2 implies only modest rotation of hinge lines. In contrast, an additional pure shear component would cause hinges in the shear plane to rotate, except those exactly parallel or perpendicular to the shear direction (Figs. 11a & b). Hence, the higher the pure shear influence, the more likely are the hinge lines to have rotated during D_2 . The data thus indicate that the deformation was at least dominated by simple shear. However, because of the high angle between the shear direction and the fold axes, the effect of a small, additional pure shear component cannot be excluded. Also, it is possible that there was a small component of extension parallel to the fold hinges (i.e. a deviation from plane strain), which helped 'fix' the hinge lines in a position normal to the movement direction.

A simple shear-dominated D_2 deformation seems reasonable also from the boundary conditions of the deformation within the décollement zone, i.e. a rigid basement and a relatively rigid Jotun and related nappes above the décollement zone. The amazingly consistent asymmetry of NW-verging D_2 structures in the décollement zone (shear bands, $S-C$ structures, asymmetric micro-folds, mesoscopic folds, asymmetric boudins, asymmetric porphyroclasts) (Rykkeliid & Fossen 1992, Fossen 1992a,b, 1993a,b) consistently overprinting the SE-verging, thrust-related deformation fabrics is considered as good evidence for a strongly noncoaxial deformation. Although conjugate shear bands and conflicting indicators may very well occur in simple shear zones due to complex internal strain partitioning (e.g. Harris & Cobbold 1984, Jiang 1994), the opposite, i.e. a distributed and uniform set of kinematic indicators in a zone dominated by coaxial deformation, is hard to comprehend.

INTERPRETATION AND DISCUSSION

Origin of the folds

There are at least two different models for the development of the NW-verging folds discussed in this paper.

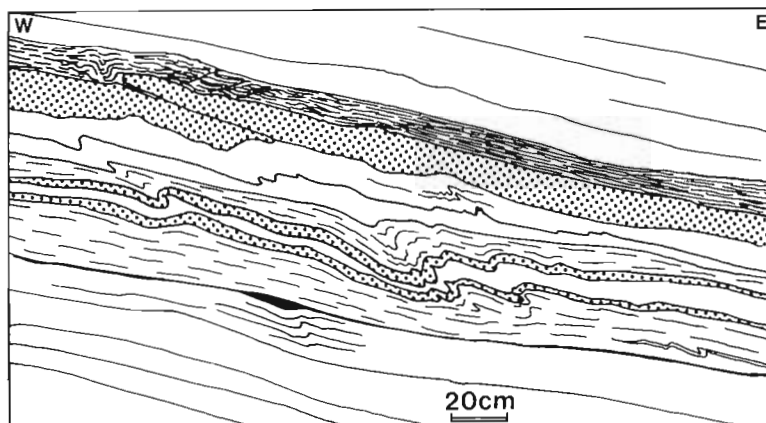

Fig. 5. Intrafolial folding in competent layers (dotted pattern) within weaker layers (dashed pattern) in gneissic tectonites. Lower Bergsdalen Nappe (Evanger). Note the absence of folds above or below this zone. Redrawn from photograph.

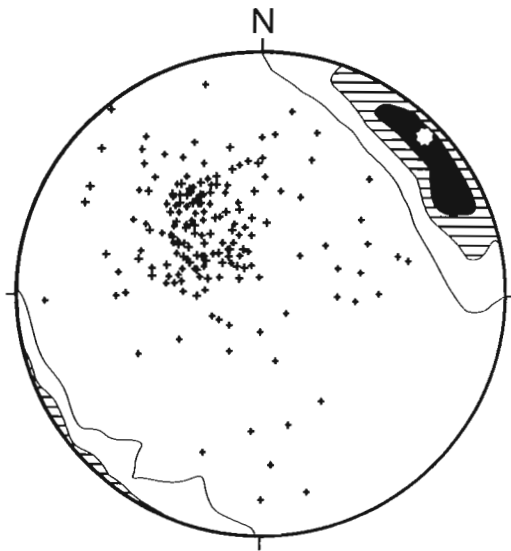

Fig. 6. Equal-area projection of 850 F_2 hinge lines. Contour interval = 2%/1% area. The maximum principal axis of the Bingham distribution of the data set is indicated (046/6). Individual points are poles to related axial surface foliations. Data from southwest Norway, mostly from the Bergsdalen Nappes.

One is that the folds are a response to slip (or heterogeneous shear) along layers inclined to the shear zone walls; the other is that folding is a more direct result of the layering being in the shortening field of the incremental D_2 strain ellipse. Both models are based on the assumption that the layering made an acute angle to the shear plane (décollement zone) at the onset of D_2 (Fig. 1).

The dominant planar fabric and layering that formed during the Caledonian thrusting (D_1) must have experienced strong noncoaxial deformation, and is therefore expected to have made a relatively small angle with the shear plane (Ramsay 1980), probably 5° or less. Evidence of intense stretching (Hossack 1968a, Fossen 1993a) supports this assumption. In addition, mylonitic fabrics and almost completely transposed layers characterize the D_1 deformation style in the quartzo-feldspatic

rocks under the Jotun Nappe, e.g. in the Bergsdalen Nappes (Fossen 1993a), the Bygdin area (Hossack 1968b), and at the northwest margin of the Jotun Nappe (e.g. Twist 1985). This tectonic D_1 layering is normally parallel to the contact to the Jotun Nappe if not disturbed by the later extensional D_2 deformation.

At the onset of D_2 , which involved reversal of the shear sense in the décollement zone, most D_1 -related planar structures were therefore dipping somewhat more steeply to the west than the subhorizontal décollement zone (shear zone) (Fig. 1a). It can be seen from Fig. 12c that the observed asymmetry of the NW-verging folds is consistent with this assumption; the layers were in the part of the shortening field close to the décollement zone (shear plane).

During D_2 (Fig. 1b), shearing occurred along the D_1 layering/foliation, particularly along centimeter to 100 m thick weak layers, resulting in a slip component normal to the shear zone. Such layer-parallel shear is evident from the many top-to-the-northwest shear indicators (asymmetric pressure shadows around garnets, oblique shape fabric in quartz veins and aggregates etc.) in weak layers situated between less deformed, competent units (e.g. Fig. 3a, see also Fossen 1993a). Layer-parallel shear must have led to a thinning of the zone, which implies a substantial volume loss and/or lateral extrusion of the décollement rocks, quite unlikely on a large scale. Hence, the processes leading to thinning of the zone are likely to have been counteracted and, on the scale of the décollement zone, balanced by folding and related shear zone-thickening processes.

In this perspective, which was theoretically explored for the case of simple shear by Dennis & Secor (1987, 1990), the formation of folds involves transfer of slip 'upward' across the layering as a response to the foliation-parallel slip (Fig. 13). In this sense, the folds and sheared-out folds may be called 'reverse-slip structures', as defined by Dennis & Secor (1987). Reverse-slip structures are seen on several scales in the field area. Within the many weak, micaceous layers with abundant

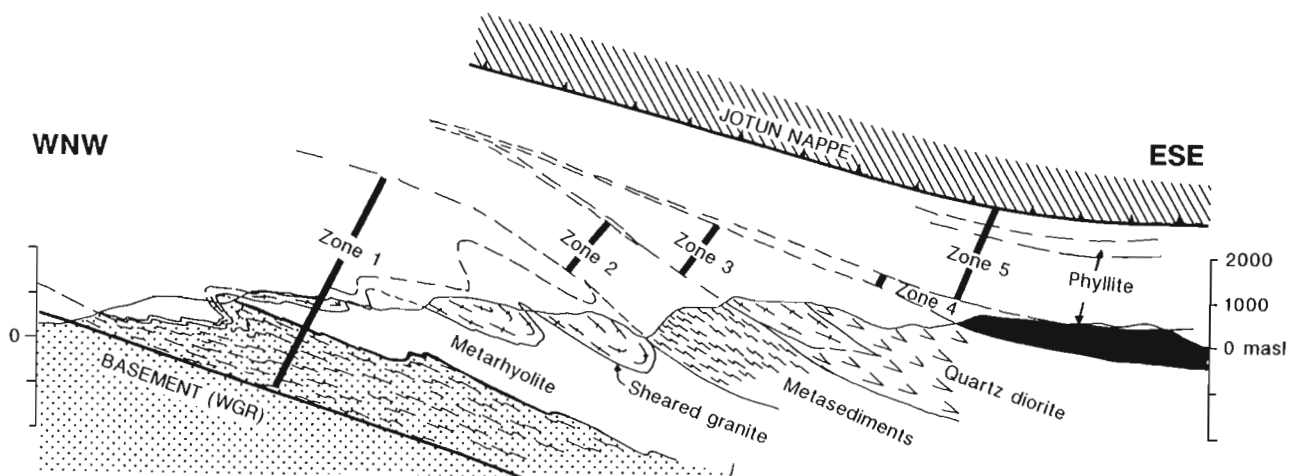

Fig. 8. Profile across the décollement zone between the Jotun Nappe and the Western Gneiss Region (basement). The décollement zone has been subdivided into several sub-zones (1–5) discussed later in the text. Note the presence of large-scale F_2 folds in zone 1. With the assumptions made in the text, strain calculation of zone 1 indicates a shear strain of about 3.5. Black zone is phyllite. See Fig. 2 for location, and text for discussion.

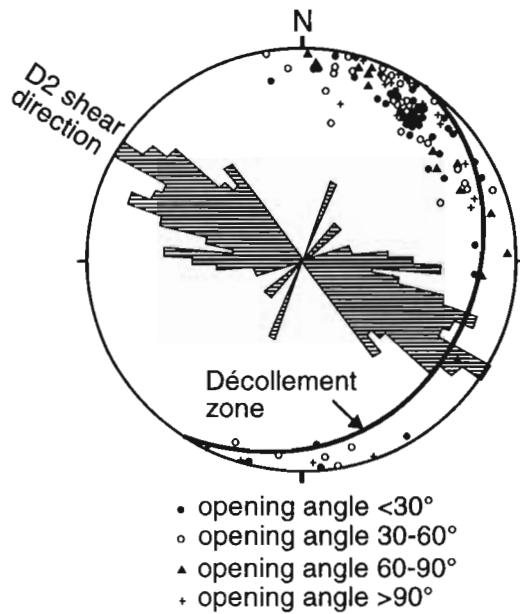

Fig. 9. Equal-area projection of back movement (F_2) folds classified according to tightness (opening angle). Symbols represent individual hinge lines. Note that there is no significant difference between the various groups of folds. The orientation of the décollement zone is indicated, and the rose diagram reflects the trend of D_2 lineations (mylonitic stretching lineations and fiber lineations) measured in the Bergsdalen Nappes from road sections in the Lower Bergsdalen Nappes along the main highway between Bergen and Voss. Radius of rose diagram = 14%.

D_2 kinematic structures there are also many intrafolial fold structures that show evidence of shear upward across the layering (Fig. 3a). Between the micaceous layers, centimeter to meter thick, competent layers respond to the D_2 shear by folding (Figs. 3c, 4, 5 and 7a), and, more exceptionally, by discrete slip (Figs. 3b and 5). The same pattern is also seen on a larger scale, where meter- to kilometer-thick, competent sheets between or next to weak, phyllitic or micaceous zones underwent folding (Fig. 8). Further discussion of such slip transfer mechanisms can be found in Rykkelid & Fossen (1992) on very similar and probably related structures in the 'Caledonized' basement in the western part of the study area, where the 'upward' transfer of slip by intrafolial folding is demonstrated.

The alternate model is that the folds formed as active folds (i.e. by buckling instabilities). Folds may have been formed as a consequence of the contrast in competence between mica-rich and quartzo-feldspatic layers, and because the layering was in the shortening field of the incremental D_2 strain ellipse (Fig. 1). This is a classical and more general model for fold development and in many cases as feasible as the one discussed above, although it is quite conceivable that both mechanisms were active during fold development. For example, buckling instabilities may have initiated many of the folds, and a gradually more passive development of the folds may have produced an oblique (reverse) slip which was balanced by the development of layer-parallel slip and extensional shear bands. Hence, both the purely kinematic model of Dennis & Secor (1987) and the more

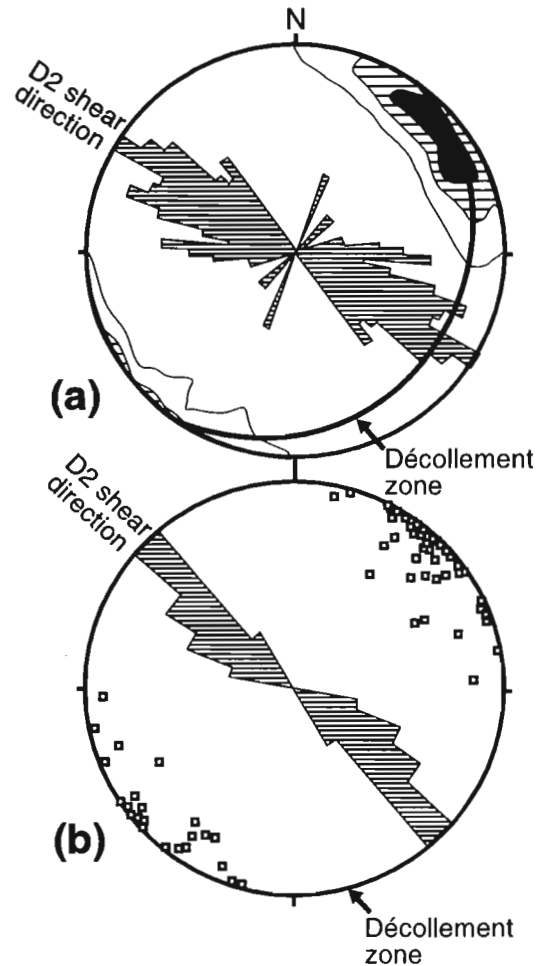

Fig. 10. (a) Contours of F_2 hinge lines in the Bergsdalen Nappes superimposed on the D_2 shear direction from Fig. 6. (b) F_2 hinge lines (squares) from the Haukelid area, and rose diagram indicating the shear direction from D_2 lineations in sheared phyllites in the same area. Most of the fold axis measurements in (b) are from Andresen (1974). Radius rose diagrams = 14%. The D_2 lineations and D_2 shear direction is determined from zones of strong D_2 deformation.

mechanical aspect involving competence contrasts are probably needed to envisage the fold development in the study area.

Quantification of the Devonian movement

The geometrics of the folds can be used to constrain the amount of back movement of the Caledonian nappes after the thrusting (D_1). As discussed above, the D_1 planar fabric and transposed lithological layering are expected to have formed a low angle (α) with the shear plane, probably less than 5° , at the end of D_1 (Fig. 1a). From detailed structural mapping in the Bergsdalen Nappes, the average D_2 shortening of the D_1 fabric by large-scale folding has been estimated. A profile (Fig. 8) parallel to the D_2 transport direction across the décollement zone west of the remnants of the Jotun Nappe in Southwest Norway clearly illustrates the geometry of large-scale folds. Unfolding the layers in the lower 4.5–5 km of the Bergsdalen Nappes in this profile (zone 1 of Fig. 8) indicates that the layering is shortened by about 30% ($1 + e = 0.7$). This must be considered a minimum

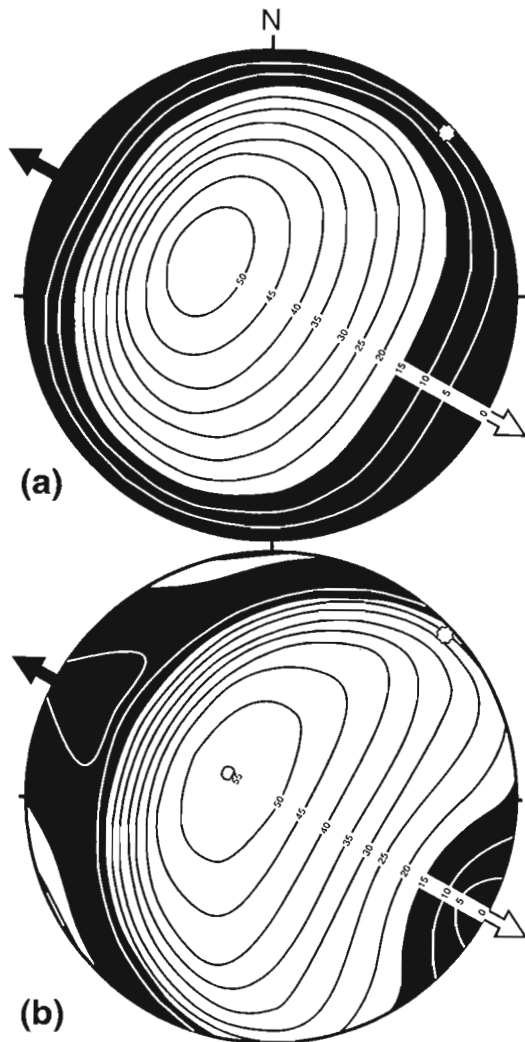

Fig. 11. (a) Stereonet (equal area) with contours that shows how much a given line will rotate for (a) a simple shear with $\gamma = 1$ (horizontal shear plane with shear direction to the northwest), and (b) the same deformation with an additional, simultaneous pure shear component (vertical shortening and stretching in the shear direction) so that the kinematic vorticity number is 0.8. Area in black illustrates area of low rotation (rotation $< 20^\circ$). Note how the low-rotation belt around the horizontal shear plane in (a) is changed in the presence of a pure shear (b). The maximum point of concentration of hinge lines from the Bergsdalen Nappes (Fig. 6) is indicated in both plots (corrected for the non-horizontal orientation of the décollement zone in this area), and shows how an additional pure shear implies a larger rotation of hinge lines with this orientation.

estimate, because no change in thickness of the layers has been assumed during the shortening process and because small-scale, parasitic folds have been neglected.

Additional information about the D_2 shortening of the layering can be obtained from the geometry of individual fold pairs mapped or observed in the field. The amount of shortening depends solely on the final geometry of the folds (long limb to short limb ratio and opening angle, see Appendix) if layer-parallel shortening is neglected and the fold geometry is approximated to chevron folds (i.e. folds with angular hinge zones). A number of large-scale folds from the Bergsdalen Nappes have been mapped and measured. The results (Fig. 14) have been plotted in a diagram and contoured for constant shortening values (see Appendix for details),

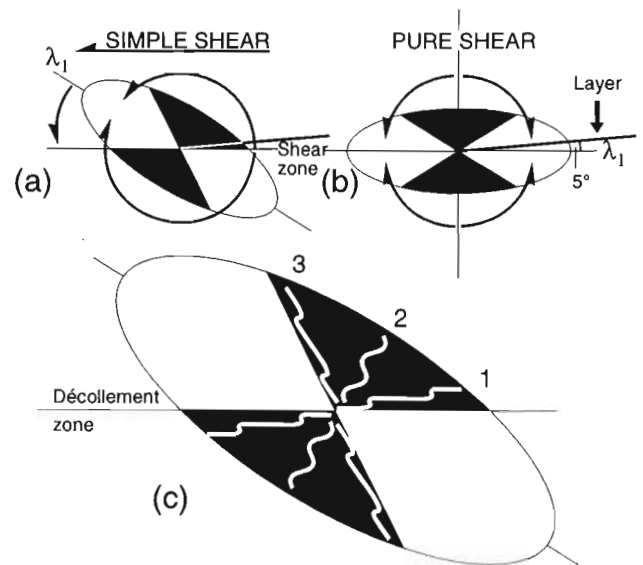

Fig. 12. Strain ellipse after an increment of (a) simple shearing ($\gamma = 1$) and (b) a corresponding strain produced by pure shearing. Black field indicate area of finite shortening. Arrows indicate direction of line rotation. Note that a gently WNW-dipping line (plane) that makes a low angle with the shear plane is in the shortening field for simple shear and rotates sympathetically with the sense of shearing, whereas for pure shearing a similarly orientated line undergoes extension and the opposite sense of rotation. (c) Strain ellipse in (a) showing how vergence depend on initial orientation of the folded layer. The Type 1 style is the one observed in the field, supporting the idea that the Caledonian planar fabric was dipping slightly more to the west-north-west than did the décollement (shear) zone at the onset of the back movement (D_2).

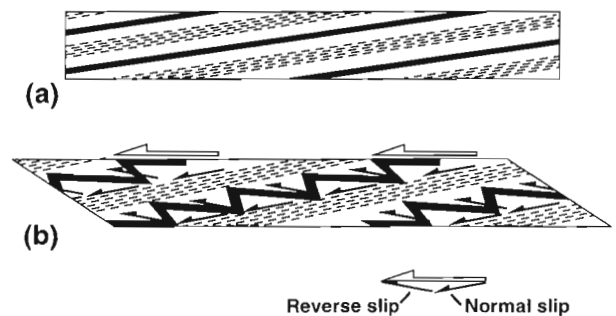

Fig. 13. Schematic illustration of how layer-parallel slip (normal slip) and folding (reverse slip) may sum up to shear zone-parallel displacement. Folded, grey layers are separated by D_2 shear zones.

and show a spread in shortening from 70% to 10% with an average between 30% and 40% (total range of mean, geometric mean and harmonic mean). Hence, the minimum estimate of about 30% shortening obtained from Fig. 8 appears to be reasonable.

The folds in the study area are generally not chevron folds, and thus this simplification results in too high shortening estimates if the curves in Fig. 14 are used, particularly for folds with α around 90° . However, the error can be shown to be small for the larger folds plotted in Fig. 14, and counteracted by the fact that smaller, parasitic folds have not been possible to take into account. Furthermore, the fact that fold limbs commonly undergo layer-parallel shortening or stretch-

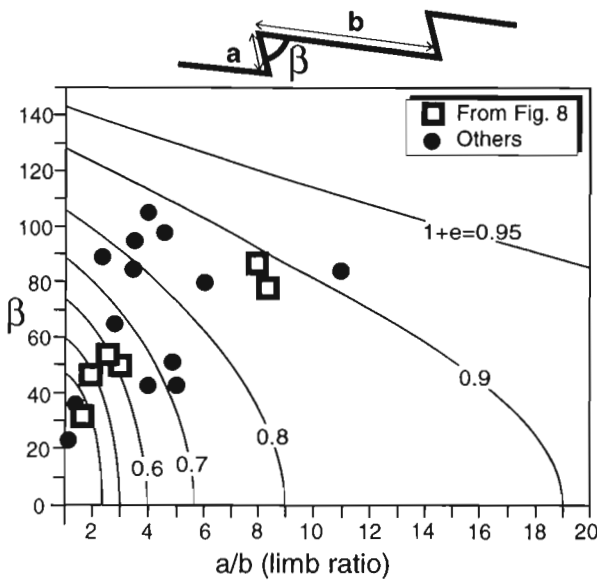

Fig. 14. Long limb over short limb ratio of large-scale folds in the Bergsdalen Nappe plotted against their opening (interlimb) angle β . Points represent individual measurements of continuous, large-scale (>100 m long) folds from constructed map profiles. Contours of constant shortening of the folded layer have been estimated (see Appendix), using the simplification that the folds have angular hinges. Note that this gives a minimum estimate of the shortening since layer-parallel shortening has been neglected. No systematic relationship between the amount of shortening and position in the décollement zone has been identified from the data.

ing also complicates the strain estimate somewhat. A small amount of thickening (shortening) of the layers is likely to occur prior to folding, as observed in physical experiments (e.g. Hudleston 1973). Progressive change in limb thickness appears to be related to the orientation of the limbs relative to the incremental strain ellipse (Fossen & Rykkelid 1990). Generally the long limb is relatively close to the shear plane, and thus more or less retains its thickness, whereas the short limb may go through a history of thickening (layer-parallel shortening) and, as it subsequently becomes inverted, experiences thinning (stretching). The amount of layer-parallel strain also depends on the physical properties of the rocks, but comparing long and short limbs of folds from the study area indicate that the effect is negligible for our purpose for folds with $\alpha > 30^\circ$.

Before discussing the implications of this shortening as far as D_2 translations are concerned, the nature of the D_2 deformation must be known. As argued above, the very consistent asymmetry of D_2 structures (folds and S-C structures) indicates strongly noncoaxial D_2 deformation (e.g. Choukroune *et al.* 1987), although a small, additional component of coaxial deformation, e.g. vertical shortening and horizontal extension (pure shear) may have been present. Several authors (e.g. Ramberg 1977, 1981) have suggested that pure shear may be an integral part of the deformation of thrust sheets. It is interesting that the Caledonian D_1 deformation in the Bergsdalen Nappes was not simple shear (Fossen 1993c), and a late, coaxial D_1 history has been suggested for the basal part of the Jotun Nappe Complex in the Bygdin area (Hossack 1968a).

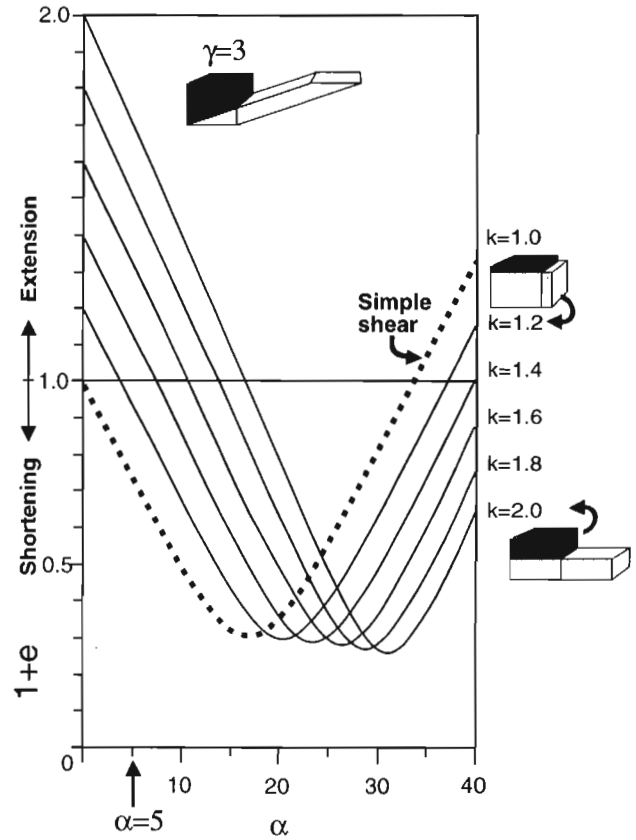

Fig. 15. Variation in line extension for various initial angles (α) in the case of simple shear alone (dashed line, $\gamma = 3$) and for simultaneous simple shear ($\gamma = 3$) and vertical pure shear (k) (solid lines). The k value is the pure shear component of the deformation (see Appendix) i.e. the extension in the shear direction and the inverse of the vertical shortening factor. For lower γ values, the set of curves will be shifted somewhat to the right and vice versa. See text for discussion.

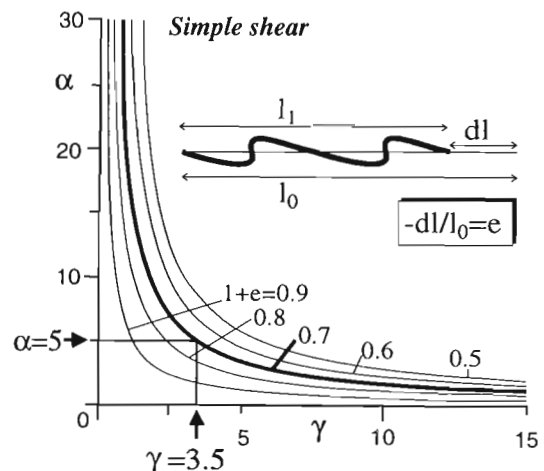

Fig. 16. Contours of constant line extension plotted for a variation in shear strain (γ) and the initial angle α between the shear zone and the line (see Fig. 1a or A1). Choosing an α value of 5° and a line extension of 0.7 gives a shear strain of 3.5. Note that this diagram is only valid for simple shear.

In our example, the extension (shortening) of lines of various initial orientations during simultaneous simple and pure shear can readily be calculated (see Appendix and Fossen & Tikoff 1993). In Fig. 15, we have chosen an example where a shear strain (γ) of 3 is combined with pure shear ranging from 0 to 50% vertical shortening ($k = 0$ to 2, respectively). With the assumption that $\alpha = 5^\circ$, even a relatively small additional component of vertical pure shear would dramatically decrease the amount of shortening of a line of this orientation (the simple shear curve in Fig. 15 will be shifted to the right). For $\alpha = 5^\circ$, the pure shear component (k) must have been less than 1.2 (20% extension parallel to the shear zone) for any shortening to have taken place at all. With $\gamma = 3$, at values of $k > 1.2$ structures with orientation $\alpha = 5^\circ$ are in the *extensional* field (Fig. 12). Hence, it is reasonable to assume that vertical shortening across the décollement zone was either absent, played a very minor role during D_2 , or the folds described above would not have developed. The D_2 deformation is therefore regarded to be close to simple shear.

If we use the estimate for shortening of the folded layers of 30% ($1 + e = 0.7$), together with $\alpha = 5^\circ$, a minimum γ of about 3.5 in zone 1 in Fig. 8 is obtained (see Fig. 16). This estimate depends on several variables, of which the value of α is most critical. For comparison, an α of 2.5 and 10° would imply a γ of about 2 and 7, respectively. Furthermore, the estimate is not necessarily representative for the entire package of rocks under the Jotun Nappe that was affected by the D_2 shearing (zones 1-5 in Fig. 8). Qualitative field observations indicate that the micaceous rocks in zones 2, 4 and 6 are marked by stronger D_2 fabrics, indicating a higher shear strain than in zone 1. On the other hand, zones 3 and 5 are more weakly affected by D_2 shearing. An average D_2 shear strain (γ) for the entire section of about 2.5-4 seems to be a reasonable estimate, based on the strain estimate from zone 1 above and on the intensity variation of D_2 fabrics in the field. Considering a thickness of 8-9 km for this zone (Bergsdalen Nappes, phyllites and uppermost, D_2 sheared part of basement) this corresponds to a displacement of the Jotun Nappe in the range of 20-36 km during the NW-directed movement.

CONCLUSIONS

A series of back folds ranging from micro- to macroscopic scale developed during the early Devonian reverse movement of the Caledonian orogenic wedge in southwestern Norway. Assuming that the foliation and lithological banding was inclined to the shear zone by a small angle ($\approx 5^\circ$) at the onset of D_2 , a series of conclusions regarding the implications of the fold structures can be achieved. Local evidence for foliation-parallel slip indicates that the folds then must have provided a component of slip 'upward' across the Caledonian foliation/layering which counteracted the slip along the foliation and the formation of shear bands. Alternatively,

some of the folds may directly result from layering being in the shortening field of the incremental strain ellipse during D_2 , as a result of buckling instabilities. Buckling may have been important during the initial stages of fold development, gradually giving way to the former and probably more important mechanism.

Folds are thought to have formed with axes lying within or close to the shear plane at a high angle to the shear direction without any significant rotation during D_2 . D_2 deformation was probably dominated by simple shear, i.e. the reverse slip provided by the folds more or less balanced the layer-parallel slip, and a strain estimate indicates back movement displacement on the order of 20-36 km. Although this is considerably less than the hundreds of kilometers of displacement estimated for the thrusting, it is nonetheless a significant displacement, and led to the development of pervasive and impressive NW-verging structures in the Caledonides of southwest Norway.

Acknowledgements—Support for this work was provided by NAVF (project 440.89/061) for the principal author. Peter J. Hudleston and A. Dennis are thanked for reviewing an early version of this paper. Critical reviews by E. A. McClellan, B. Hatcher and an unknown reviewer further improved the text.

REFERENCES

- Andersen, T. B. 1993. The role of extensional tectonics in the Caledonides of South Norway: Discussion. *J. Struct. Geol.* **15**, 1379-1380.
- Andresen, A. 1974. Petrographic and structural history of the Caledonian rocks north of Haukelisæter, Hardangervidda. *Norges geol. unders.* **314**, 1-52.
- Banham, P. H., Gibbs, A. D. & Hopper, F. W. M. 1979. Geological evidence in favour of a Jotunheimen Caledonian suture. *Nature* **277**, 289-291.
- Bryhni, I. & Sturt, B. A. 1985. Caledonides of southwestern Norway. In: *The Caledonide Orogen—Scandinavia and Related Areas* (edited by Gee, D. G. & Sturt, B. A.). J. Wiley & Sons, 89-107.
- Choukroune, P., Gapais, D. & Merle, O. 1987. Shear criteria and structural symmetry. *J. Struct. Geol.* **9**, 525-530.
- Cobbold, P. R. & Quinquis, H. 1980. Development of sheath folds in shear regions. *J. Struct. Geol.* **2**, 119-126.
- Dennis, A. J. & Secor, D. T. 1987. A model for the development of crenulations in shear zones with applications from the Southern Appalachian Piedmont. *J. Struct. Geol.* **9**, 809-817.
- Dennis, A. J. & Secor, D. T. 1990. On resolving shear direction in foliated rocks deformed by simple shear. *Bull. geol. Soc. Am.* **102**, 1257-1267.
- Fossen, H. 1992a. Devonian extensional deformation in the Caledonian orogen, southern Norway. Ph.D. thesis, University of Minnesota.
- Fossen, H. 1992b. The nature and significance of extensional tectonics in the Caledonides of South Norway. *J. Struct. Geol.* **14**, 1033-1046.
- Fossen, H. 1993a. Structural evolution of the Bergsdalen Nappes, southwest Norway. *Norges geol. unders.* **424**, 23-50.
- Fossen, H. 1993b. The role of extensional tectonics in the Caledonides of South Norway: Reply. *J. Struct. Geol.* **15**, 1381-1383.
- Fossen, H. 1993c. Linear fabrics in the Bergsdalen Nappes, southwest Norway: Implications for deformation history and fold development. *Norsk Geol. Tidsskr.* **73**, 95-108.
- Fossen, H. & Rykkelid, E. 1990. Shear zone structures in the Øygarden Complex, western Norway. *Tectonophysics* **174**, 385-397.
- Fossen, H. & Rykkelid, E. 1992. Post-collisional extension of the Caledonide orogen in Scandinavia: structural expressions and tectonic significance. *Geology* **20**, 737-740.
- Fossen, H. & Tikoff, B. 1993. The deformation matrix for simultaneous simple shearing, pure shearing, and volume change, and its application to transpression/transension tectonics. *J. Struct. Geol.* **15**, 413-422.

- Gee, D. 1978. Nappe emplacement in the Scandinavian Caledonides. *Tectonophysics* **47**, 393–419.
- Gray, J. W. 1978. Structural history and Rb–Sr geochronology of Eksingedalen, west Norway. Ph.D. thesis, University of Aberdeen.
- Harris, L.B. & Cobbold, P.R. 1984. Development of conjugate shear bands during bulk simple shearing. *J. Struct. Geol.* **7**, 37–44.
- Hossack, J. R. 1968a. Pebble deformation and thrusting in the Bygdin area (Southern Norway). *Tectonophysics* **5**, 315–339.
- Hossack, J. R. 1968b. Structural history of the Bygdin area, Oppland. *Norges geol. unders.* **247**, 78–107.
- Hossack, J. R. & Cooper, M. A. 1986. Collision tectonics in the Scandinavian Caledonides. In: *Collision Tectonics* (edited by Coward, M.P. & Ries, A.). *Spec. Pap. Geol. Soc. Lond.* **19**, 287–304.
- Hudleston, P. J. 1973. An analysis of 'single-layer' folds developed experimentally in viscous media. *Tectonophysics* **16**, 189–214.
- Hudleston, P. J. 1977. Progressive deformation and development of fabric across zones of shear in glacial ice. In: *Progressive Deformation and Development of Fabric Across Zones of Shear in Glacial Ice* (edited by Saxena, S. K. & Bhattachari, S.). Springer-Verlag, New York, 121–150.
- Jiang, D. 1994. Vorticity determination, distribution, partitioning and the heterogeneity and non-steadiness of natural deformations. *J. Struct. Geol.* **16**, 121–130.
- Kvalc, A. 1948. Petrologic and structural studies in the Bersdalen quadrangle, western Norway Part II. Structural geology. Bergen Museums Årbok 1946–1947, Naturvit. rekke.1.
- Lutro, O. 1990. Mørkisdalen. Description of the bedrock geological map AMS-M711 111418, scale 1:50 000. *Norges geol. unders. Skrifter* **94**, 1–24.
- Milnes, A. G. & Koestler, A. G. 1985. Geological structure of Jotunheimen, southern Norway (Sognefjell–Valdres cross-section). In: *The Caledonide Orogen–Scandinavia and Related Areas* (edited by Gee, D. G. & Sturt, B. A.). John Wiley & Sons, 457–474.
- Milnes, A. G., Dietler, T. N. & Koestler, A. G. 1988. The Sognefjord northshore log—a 25 km depth section through Caledonized basement in western Norway. *Spec. Publ. Norg. Geol. Unders.* **3**, 114–121.
- Naterstad, J., Andresen, A. & Jorde, K. 1973. Tectonic succession of the Caledonian nappe front in the Haukeli–Røldal area, southwest Norway. *Norges geol. unders.* **292**, 1–20.
- Ramberg, H. 1977. Some remarks on the mechanism of nappe movement. *Geol. För. Stockholm Förh.* **99**, 110–117.
- Ramberg, H. 1981. The role of gravity in orogenic belts. In: *Thrust and Nappe Tectonics* (edited by McClay, K. R. & Price, N.J.). *Spec. Pap. Geol. Soc. Lond.* 125–140.
- Ramsay, J. G. 1980. Shear zone geometry: a review. *J. Struct. Geol.* **2**, 83–99.
- Roberts, J.L. 1977. Allochthonous origin of the Jotunheimen Massif in southern Norway: a reconnaissance study along its north-western margin. *J. geol. Soc. Lond.* **134**, 351–362.
- Rykkeliid, E & Fossen, H. 1992. Composite fabrics in mid-crustal gneisses: observations from the Øygarden Complex, West Norway. *J. Struct. Geol.* **14**, 1–9.
- Skjerna, L. 1980. Rotation and deformation of randomly oriented planar and linear structures in progressive simple shear. *J. Struct. Geol.* **2**, 101–109.
- Twist, D. 1985. The structural history of the northwestern margin of the Jotunheimen Massif. *Norsk Geol. Tidsskr.* **65**, 151–165.
- Vollmer, F. W. 1988. A computer model of sheath-nappes formed during crustal shear in the Western Gneiss Region, central Norwegian Caledonides. *J. Struct. Geol.* **10**, 735–745.

APPENDIX

The shortening of a folded layer is unique for a fixed fold geometry. For simplicity we have approximated the folds as chevron folds, in which case only the long limb to short limb (a/b) ratio and the opening angle (β) of the fold determine the amount of shortening involved. From Fig. A1 we have that

$$l_1 = \frac{\Delta y}{\sin \phi} = \frac{b \sin \beta}{\sin \phi} = \frac{b \sin \beta}{\sin \left[\tan^{-1} \left(\frac{b \sin \beta}{a - b \cos \beta} \right) \right]}, \quad (\text{A1})$$

i.e. l_1 in terms of a , b , and β . Knowing $l_0 = a + b$, the extension (e) is defined as

$$e = (l_1 - l_0)/l_0 \quad (\text{A2})$$

and the amount of shortening as

$$-e \cdot 100\%.$$

The diagram in Fig. 15 was made by using the deformation matrix \mathbf{D} for simultaneous simple and pure shear:

$$\mathbf{D} = \begin{bmatrix} k & \Gamma \\ 0 & k^{-1} \end{bmatrix} = \begin{bmatrix} k & \frac{\gamma(k - k^{-1})}{2 \ln k} \\ 0 & k^{-1} \end{bmatrix} \quad (\text{A3})$$

where k is the pure shear component and γ the simple shear component of the deformation. The transformation (deformation) equation

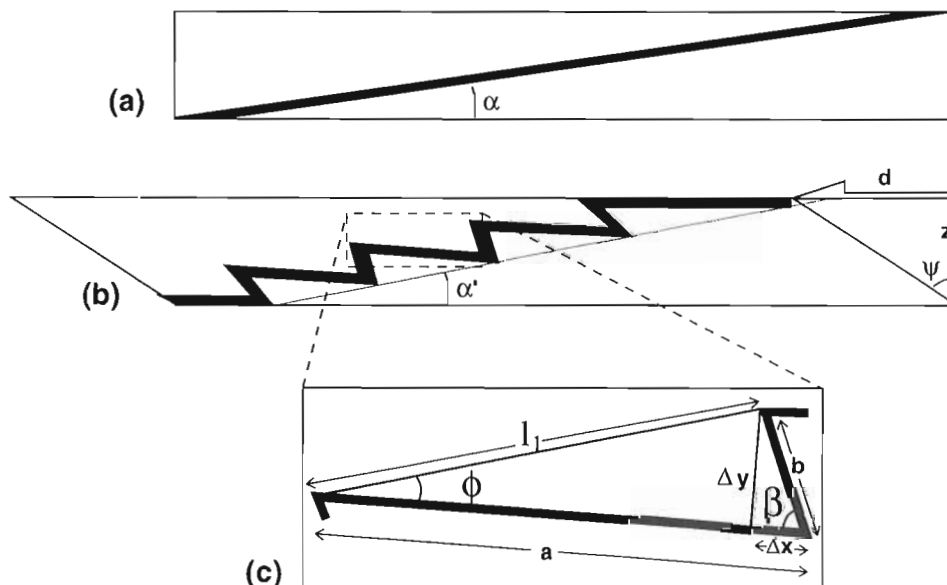

Fig. A1. The geometric relationships and notation used in estimating the shortening of the black line (a) after folding (b) are shown in (c).

$$I' = DI$$

(A4)

enables us to study the extension (shortening) as well as change in orientation of any line from its initial orientation, given by the unit

vector I (made up of the direction cosines of the line) that in the text was chosen to make 5° with the shear plane, to the new direction I' . The extension is given by the length of the new vector I' (see Fossen & Tikoff 1993 for details).

